

NOTES:

1. SUBSTRATE
Sapphire (Al₂O₃)
Axis Orientation: Random
2. COATING (APPLY ACROSS CLEAR APERTURE)
S1 & S2: NONE
3. SURFACE S2 TO BE PARALLEL TO SURFACE S1 TO WITHIN ≤ 3.5 ARCMIN
4.  FINE GRIND SURFACE
5. ROHS COMPLIANT

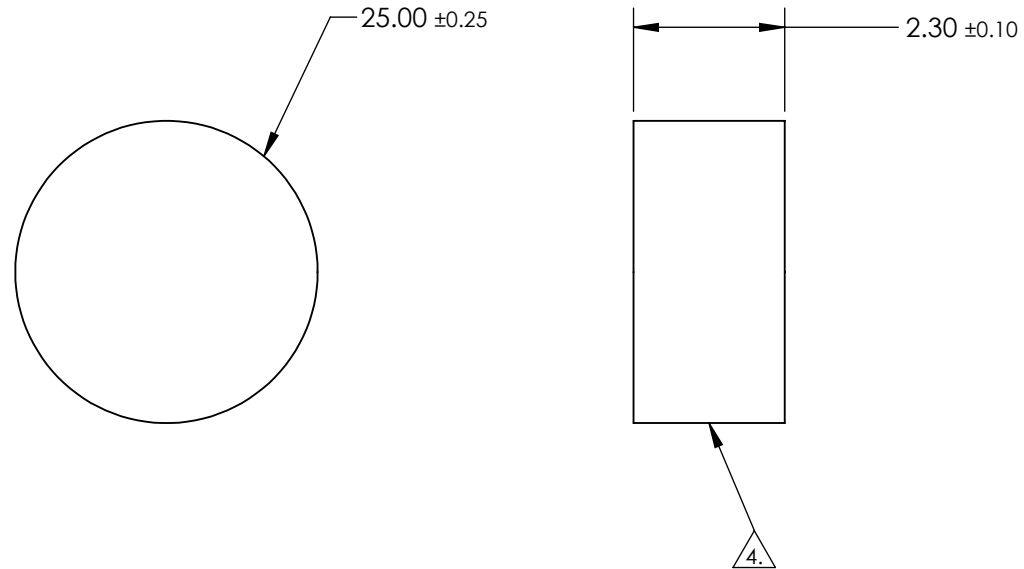

**FOR INFORMATION ONLY:
DO NOT MANUFACTURE
PARTS TO THIS DRAWING**

SPECIFICATIONS SUBJECT TO CHANGE WITHOUT NOTICE
DIMENSIONS ARE FOR REFERENCE ONLY

	S1	S2
SHAPE	PLANO	PLANO
SURFACE QUALITY	80 - 50	80 - 50
SURFACE FLATNESS	2λ (typical)	2λ (typical)
CLEAR APERTURE	∅ 22.50	∅ 22.50
BEVEL	PROTECTED AS NEEDED	PROTECTED AS NEEDED



ALL DIMS IN mm

 **Edmund Optics®**

TITLE 25mm Dia., 2.3mm Thick, Uncoated, Sapphire Window

DWG NO 43369 SHEET 1 OF 1