

CORNING

Varioptic® Lenses



Marketing Datasheet

Corning® Varioptic® AF Explorer Development Kit

Overview

The Corning® Varioptic® AF Explorer development kit is a comprehensive platform that produces fast and reliable auto focus based on Corning Varioptic liquid lens technology. The kit consists of several PCB boards with associated software and is provided in a ready-to-use format.

The kit is best suited for camera developers who want to evaluate and study characteristics of the liquid lens, whether that be imaging performance, auto focus performance, or any other standard camera function. In addition to the evaluation platform, the kit can also be used as a reference design. The related source code layout and unique ISP are also available, please contact your Corning Varioptic sales associate for pricing and conditions.

Several types of sensor boards and liquid lens modules are supported by this kit, but the default configuration includes a Sony® IMX335 5Mpx sensor. Furthermore, it is fully compliant with USB and UVC standards, therefore no other driver is required to interface it. For more detailed information on the kit, please refer to the AF Explorer User Guide (MAUG).

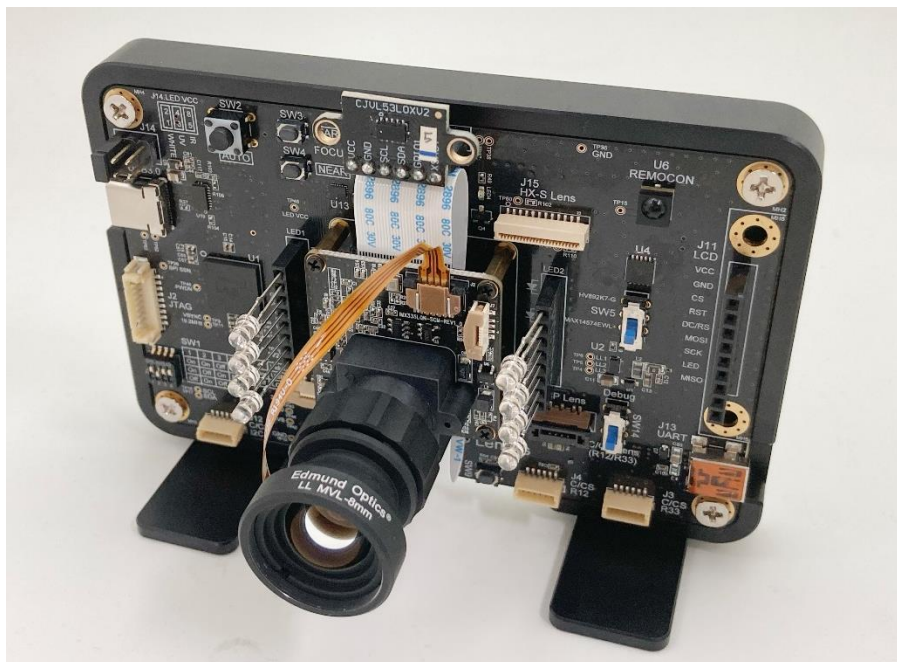

Liquid lens module to be purchased separately
Sony® is a registered trademark of Sony Corporation.

Contents

Features	2
Contents of the Kit	2
Reference Design	4
Main Board Description	4
Optional Sensor Boards.....	5
PCB Dimension	6
AF Lab Software.....	8

Features

- Liquid lens-based camera development board for developers and users
- Auto Focus (AF)
 - Contrast-based AF for still capture (Hill Detection, Fibonacci, Dichotomy, Full Scan)
 - Contrast-based AF for video mode (Continuous Auto Focus – CAF)
 - Closed loop-based AF – based on Time of Flight (TOF) sensor for still capture or video mode
 - Thermal compensation
- Image pipeline reference design
- Application software (AF Lab) for Windows®:
 - Continuous / Manual Auto Focus with choice of several algorithms
 - Region of Interest (ROI) Control and Switched Focus function
 - Auto Exposure (AE) / Auto White Balance (AWB) / Auto Gain Control (AGC)
 - Manual control also available
 - Image & video capture
 - Direct register access of Sensor and ISP (Read/Write/Dump)
 - Display of sensor information (Temperature, TOF, 3-axis sensor)
 - Lens distortion correction algorithm
 - Color temperature selection (Daylight / Fluorescent / incandescent / Auto)
- Supports several types of Sensor boards, which are interchangeable
- Uncompressed YUV format and Compressed MJPEG format
- Maximum Resolution: 2592x1944(5MP), 3264x2488(8MP)
- Supports Corning® Varioptic® C-series Modules, Edmund Optics® Techspec® Liquid Lens M12 and C-x Series modules as well as Corning® Varioptic® A-PE-series products (liquid lenses and modules with associated control boards, including response time optimization and thermal compensation)
- Selectable LED lighting: White/UV/IR (470nm, 395nm, 950nm)
- Selectable video output - USB Video or LCD video output
- Support 2.8” SPI TFT LCD Interface (not included in the kit, available as an option)
- JTAG & USB to UART support for programming and debugging
- Eight buttons for dedicated functions
- USB 3.1 GEN1 device with Type C reversible interface connector.
- Plug-and-Play setup (UVC compliant) for Windows® 7, 8.1, 10 and Ubuntu® 12.04, 14.04

Windows® is a registered trademark of the Microsoft Corporation.
Ubuntu® is a registered trademark of Canonical Ltd.

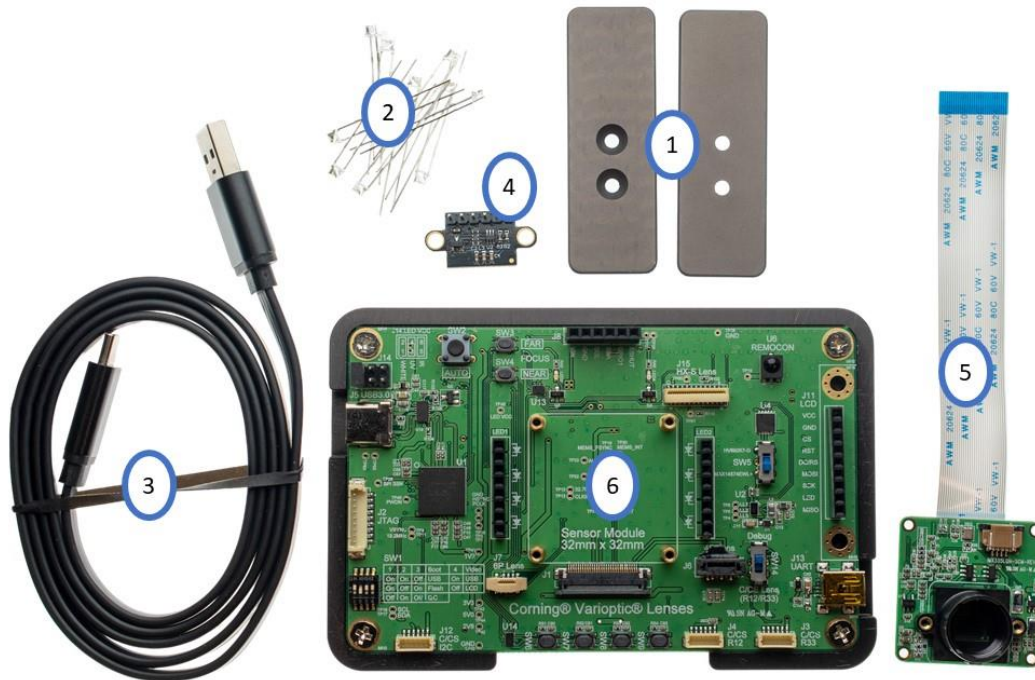

1. Pedestals
2. White LEDs
3. USB3.0 Type-C Cable
4. TOF Sensor
5. Sensor Board
(default configuration includes the Sony® IMX335 5Mpx sensor -1/2.8")
6. Main Board based on Cypress EZ-USB® CX3 chip

Sony® is a registered trademark of Sony Corporation.
EZ-USB® is a registered trademark of Cypress Semiconductor Corporation.

Reference Design

The AF Explorer has been developed around the Cypress EZ-USB® CX3 chip and a specific ISP (available from Corning upon request). It is based on an MIPI pipeline between sensor, ISP, and embedded host.

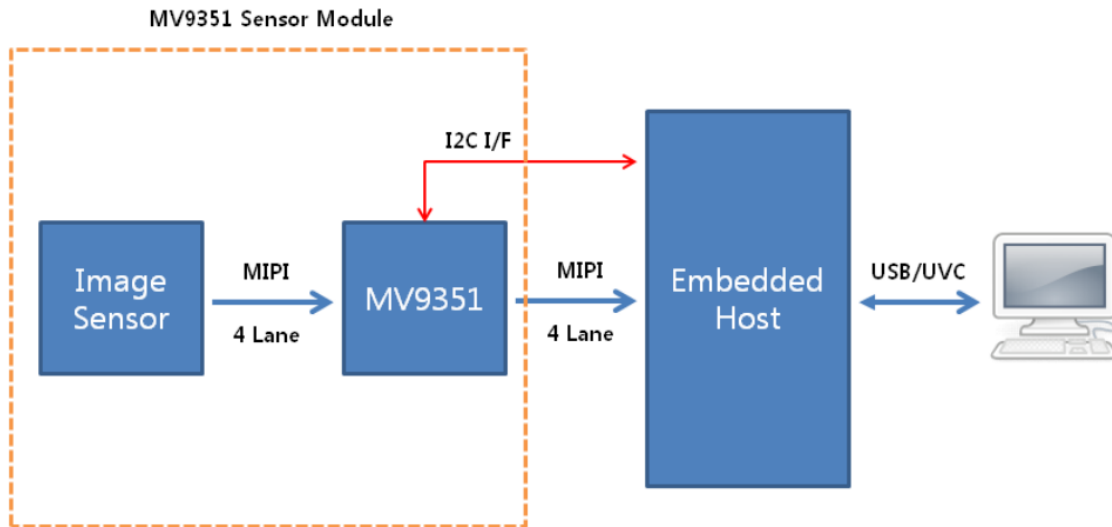

The system includes several types of auto focus algorithms (either open- or close-loop) and can support several models of Corning Varioptic C-Series and Edmund Optic Techspec liquid lens modules. The source code of this reference design can be made available.

Main Board Description

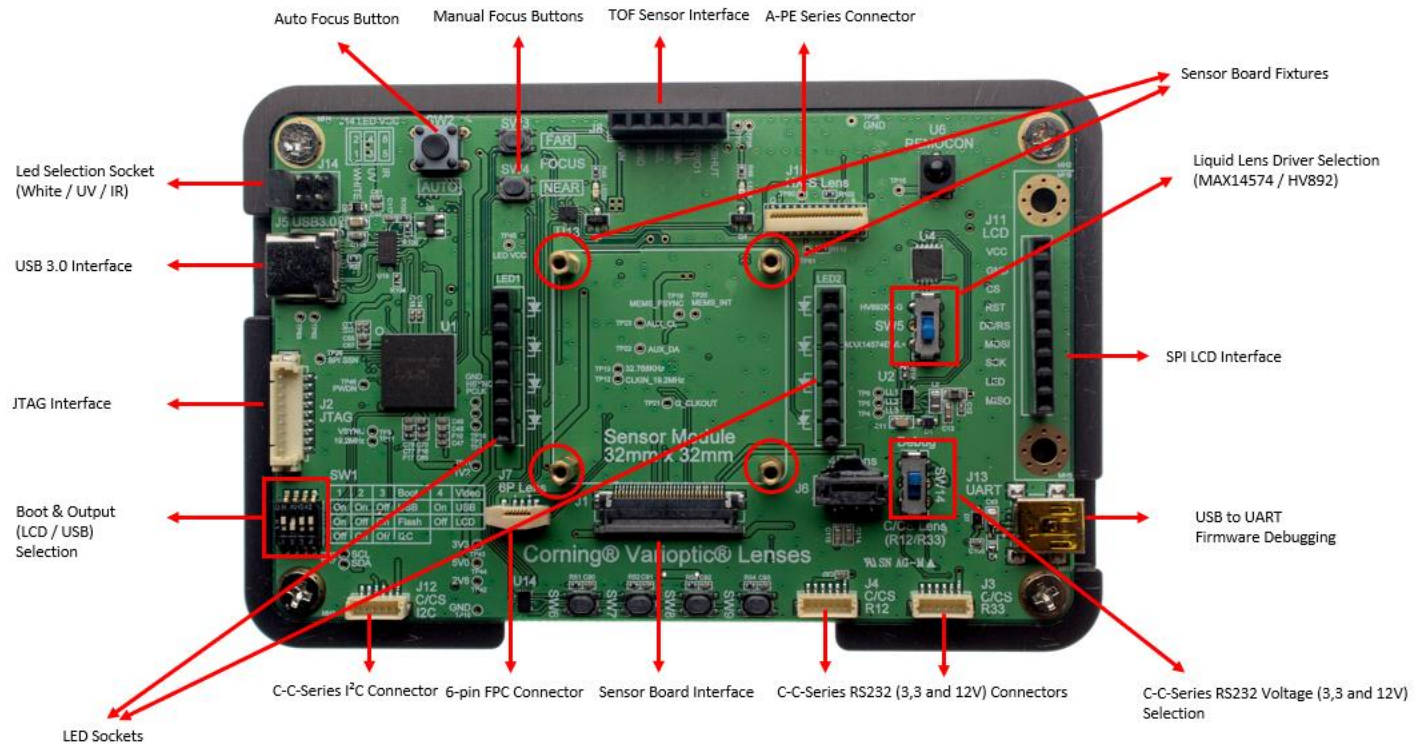

EZ-USB® is a registered trademark of Cypress Semiconductor Corporation.

Optional Sensor Boards

Several additional sensor boards are available upon request:

- Sony® IMX 307 (1/2,8" - 2Mp – 2,9µm – Rolling Shutter)
- Sony® IMX 335 (1/2,8" - 5Mp – 2µm – Rolling Shutter) – Default sensor board
- Sony® IMX 219 (1/4" - 8 Mp – 1.2µm – Rolling Shutter)
- Samsung® M3085 (1/3.2" - 8Mp – 1.4µm – Rolling Shutter)

All sensor boards will be connected to the main board with a 30 pin FPC cable.

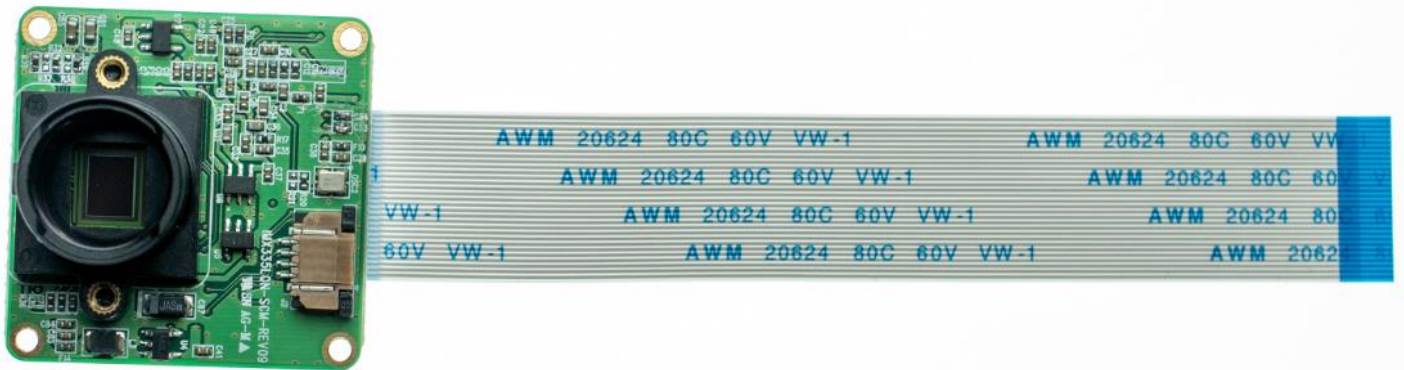

The following table lists framerate of the different sensors based on configuration:

Sensor	Resolution	USB 2.0		USB 3.0	
		MJPG	YUV	MJPG	YUV
Sony IMX219 (8MP)	3264x2448			15 fps	
	3216x1800	8 fps		20 fps	
	2568x1440	10 fps		30 fps	
	1920x1080	15 fps		30 fps	
	1280x720	15 fps		30 fps	
	640x480	30/60 fps	30 fps	30/60 fps	30 fps
Samsung M3085 (8MP)	3264x2448	8 fps		20 fps	
	3216x1800	10 fps		30 fps	
	2568x1440	15 fps		30 fps	
	1920x1080	30 fps		30/60 fps	30 fps
	1280x720	30 fps	15 fps	30/60 fps	30 fps
	640x480	30/60 fps	30 fps	30/60 fps	30 fps
Sony IMX335 (5MP)	2592x1944	15 fps		30 fps	
	2568x1440	15 fps		30 fps	
	1920x1080	30 fps		30/60 fps	30 fps
	1280x720	30 fps	15 fps	30/60 fps	30 fps
	640x480	30/60 fps	30 fps	30/60 fps	30 fps
Sony IMX307 (2MP)	1920x1080	30 fps		30/60 fps	30 fps
	1280x720	30 fps	15 fps	30/60 fps	30 fps
	640x480	30/60 fps	30 fps	30/60 fps	30 fps

Sony® is a registered trademark of Sony Corporation.

Samsung® is a registered trademark of Samsung Electronics Co., Ltd.

Liquid Lens Module Holders

Four different liquid lens module holders are available in the kit in order to ensure the appropriate back focal length between the liquid lens module and the sensor:

- C-mount holder for
 - C-C-39N0-160
 - C-C-39N0-250
 - Techspec® #33-562 12mm EFL
 - Techspec® #33-563 16mm EFL
 - Techspec® #33-564 25mm EFL
 - Techspec® #33-565 35mm EFL
- M12 7mm holder for
 - C-S-25H0-036
 - C-S-25H0-047
- M12 10mm holder for
 - C-S-25H0-075
 - C-S-25H0-096
 - Techspec® #37-521 6mm EFL
 - Techspec® #37-522 8mm EFL
- M12 14.5mm holder for
 - C-S-25H0-026
 - C-S-39N0-158
 - Techspec® #37-523 12mm EFL
 - Techspec® #37-524 16mm EFL

PCB Dimension

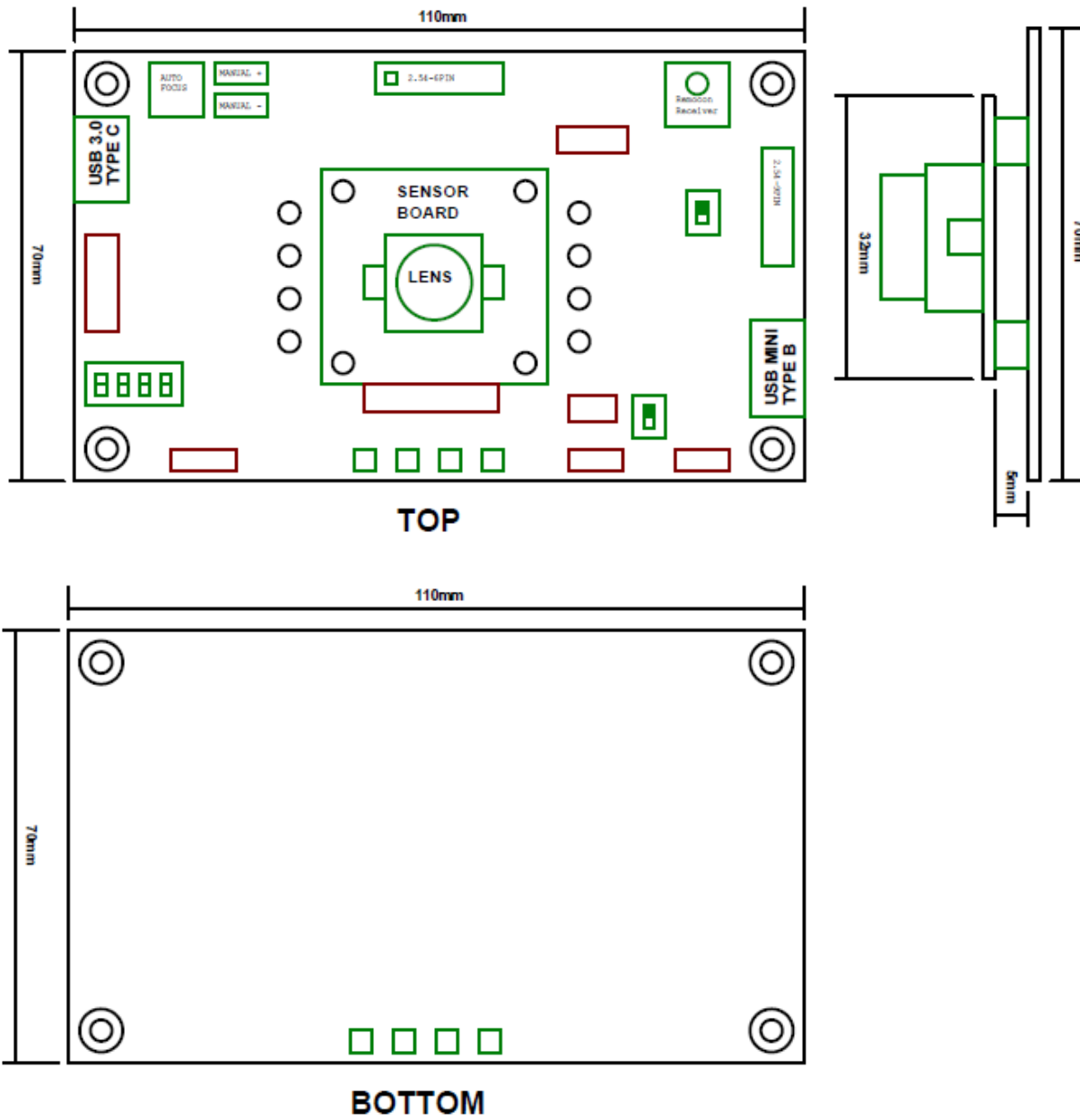

AF Lab Software

The kit includes a Windows®-compatible software called AF Lab. This software allows users to acquire images, record video, and control every part of the kit including the liquid lens. The software also incorporates standard camera functions such as Auto White Balance and Auto Gain. For more detailed information on AF Lab, please refer to the AF Explorer User Guide (MAUG).

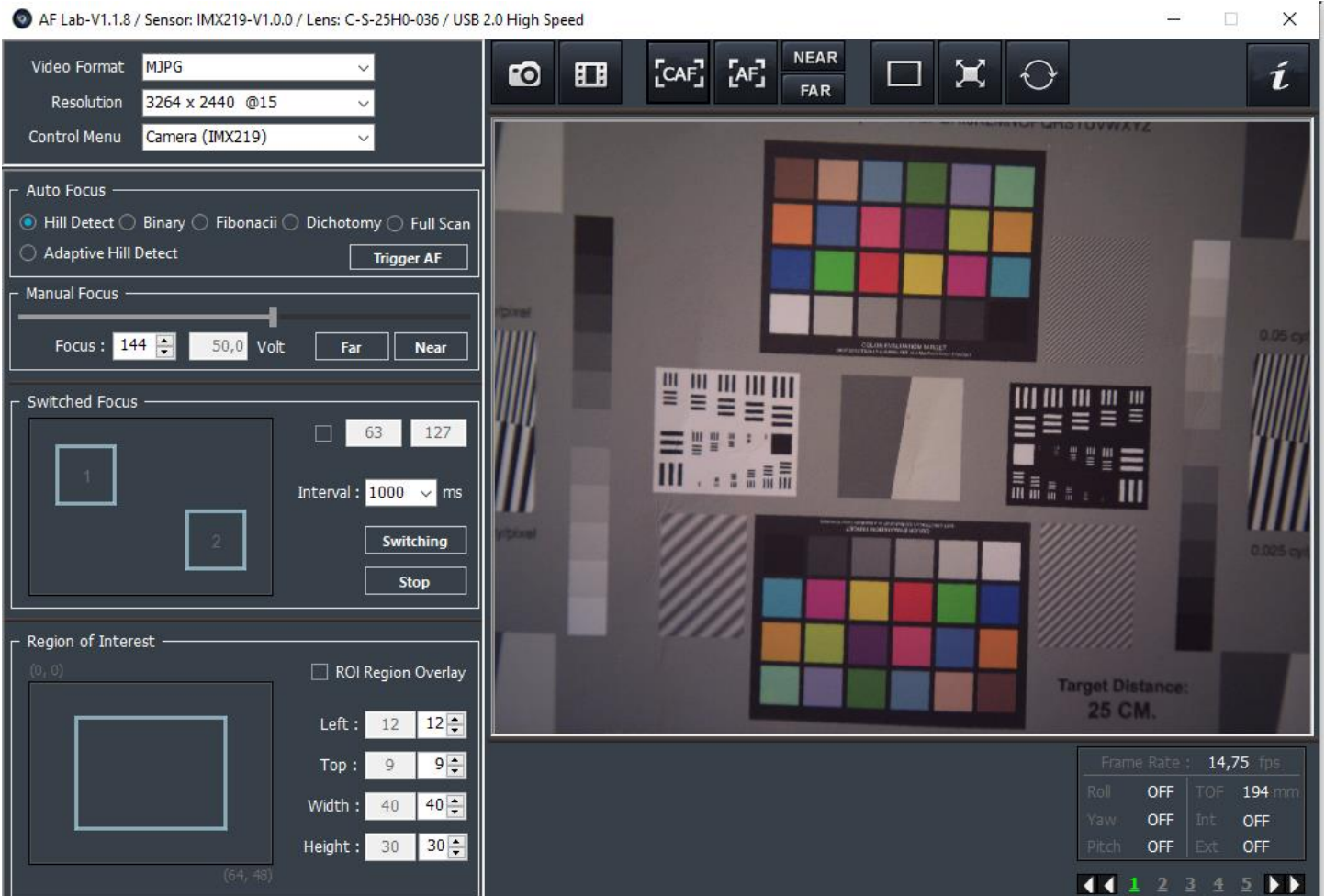

Corning reserves the right to change its product specifications at any time without notice. Please ensure you have the latest applicable specification before purchasing a Corning product. It is the customer's responsibility to determine the suitability of Corning's product to its own application. Corning does not provide any warranty of merchantability or fitness for a particular purpose. Product specifications are available upon request at varioptic@corning.com.

Windows® is a registered trademark of the Microsoft Corporation.